



Dosatore di scarico con Silenziatore in bronzo sinterizzato fil. G 1/2" M



DATI TECNICI

Pressione max. esercizio

10 bar

Temperatura ambiente

-10 ÷ 85 °C

Avvertenze Tecniche

DIMENSIONI

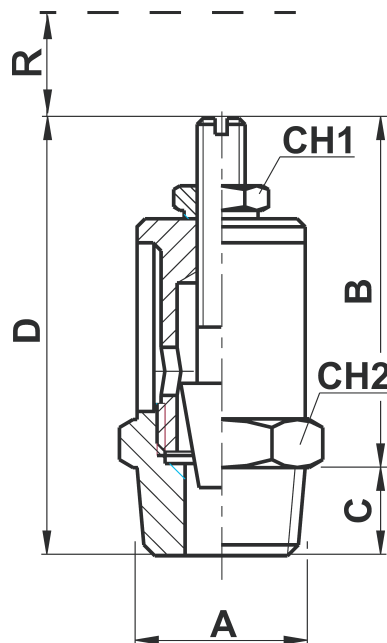

A	B	C	D	R	CH1	CH2
G 1/2"	37	13	50	13	10	22



Materiali

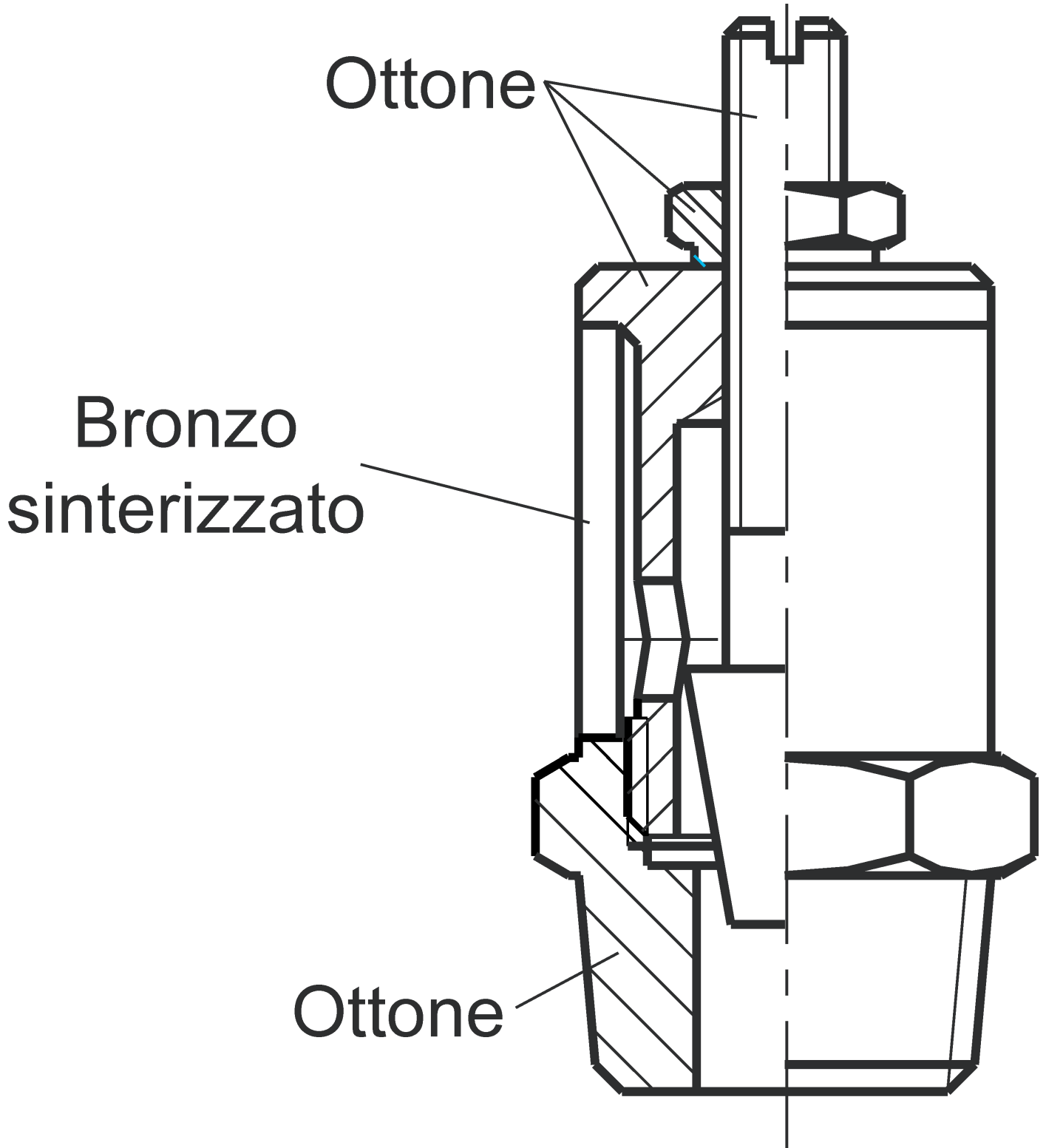

Originale: 3198x3559 px (270.8x301.3 mm) | Mostrata: 184.2x205.0 mm | Ridimensionata: Sì