

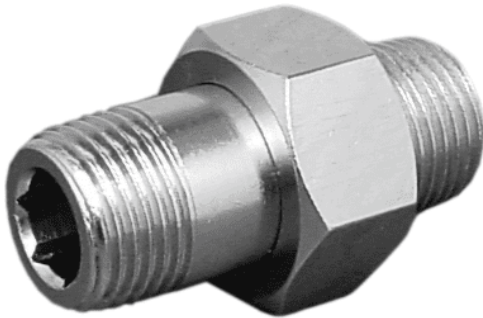

Raccordo in 3 pezzi MM conico R 3/4"



DATI TECNICI

Pressione max. esercizio	10 bar
Temperatura ambiente	-10 ÷ 85 °C
Coppia di serraggio del dado	36 Nm

Avvertenze Tecniche

OPZIONI A RICHIESTA

135.77.V Con tutte le guarnizioni in FKM

DIMENSIONI

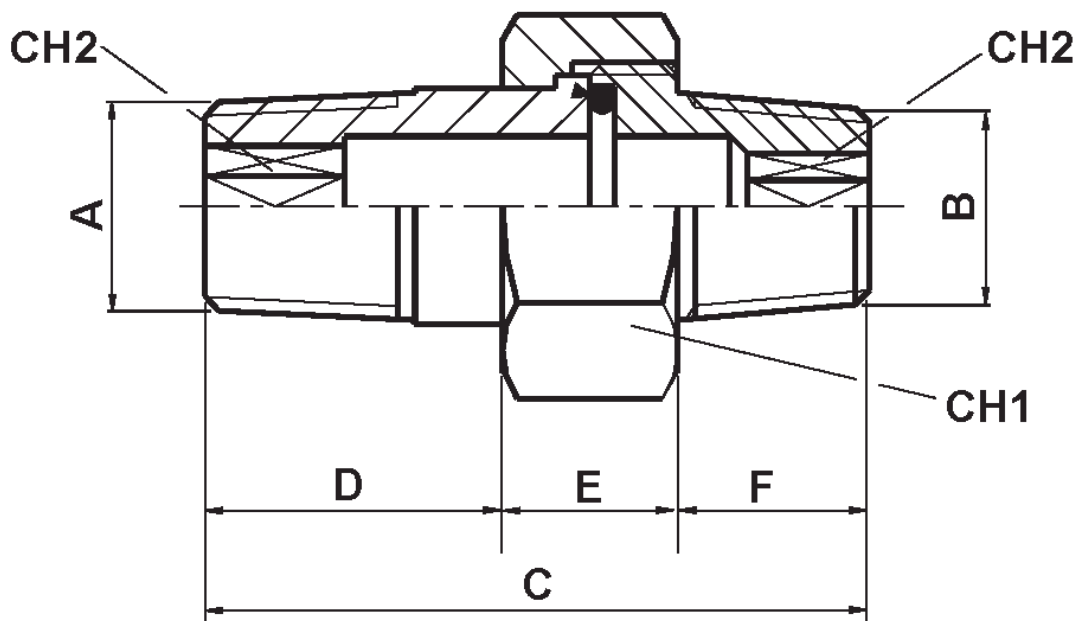

A	B	C	D	E	F	CH1	CH2
R 3/4"	R 3/4"	54	19	17	18	36	18

Materiali

Ottone nichelato

O-Ring
NBR

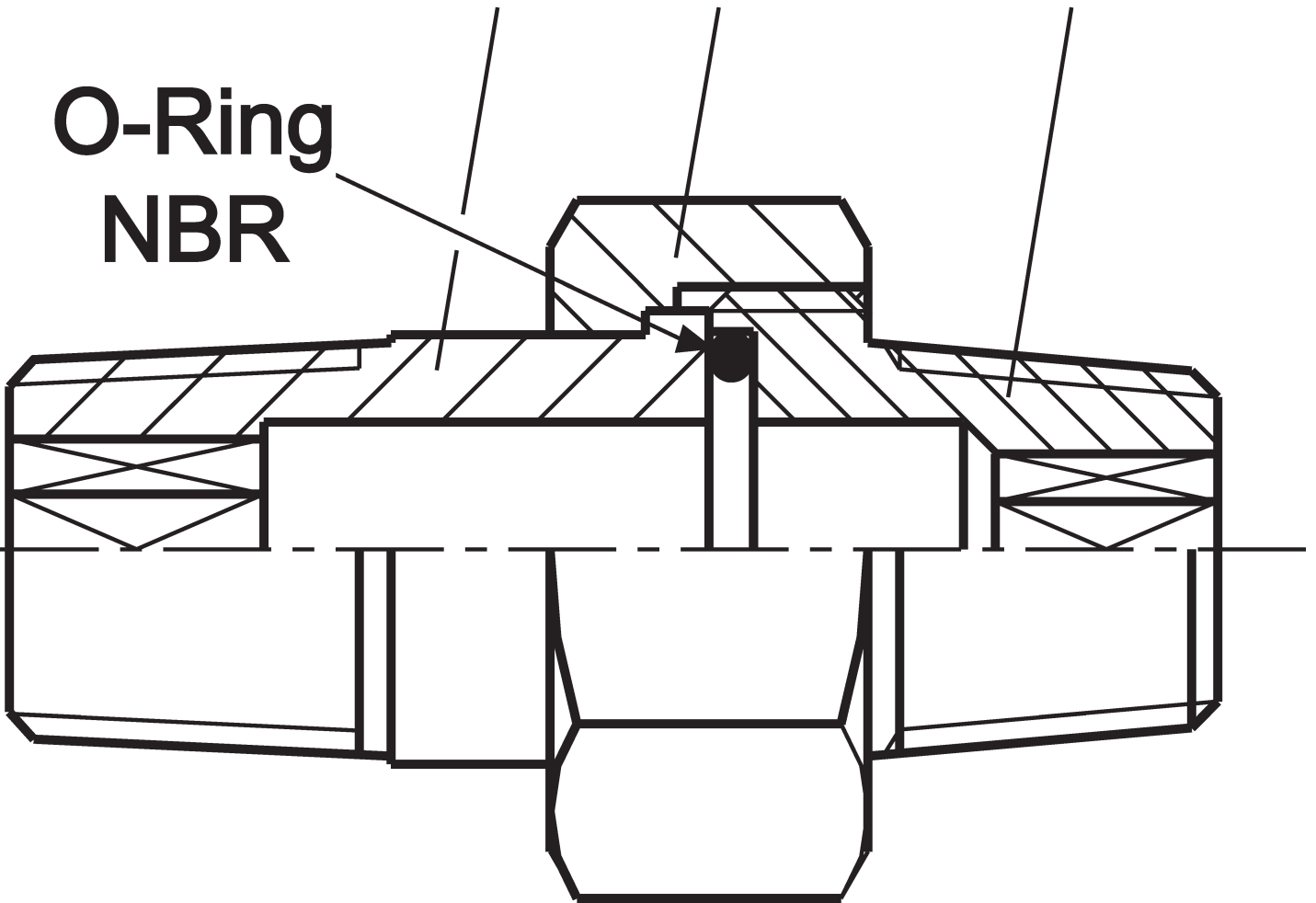

Originale: 4882×3686 px (413.3×312.1 mm) | Mostrata: 189.0×142.7 mm | Ridimensionata: Sì