

Valvola posizionatrice G 3/8" F centri aperti con ghiera per fissaggio a pannello



DATI TECNICI

Pressione esercizio	0 ÷ 10 bar
Temperatura ambiente	-5 ÷ 60 °C
Fluido	Aria filtrata a 40 micron
Guarnizioni	NBR

Avvertenze Tecniche

OPZIONI A RICHIESTA

VPG038CA.P	Fissaggio a pannello con ghiera
-------------------	---------------------------------

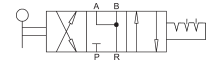

DIMENSIONI

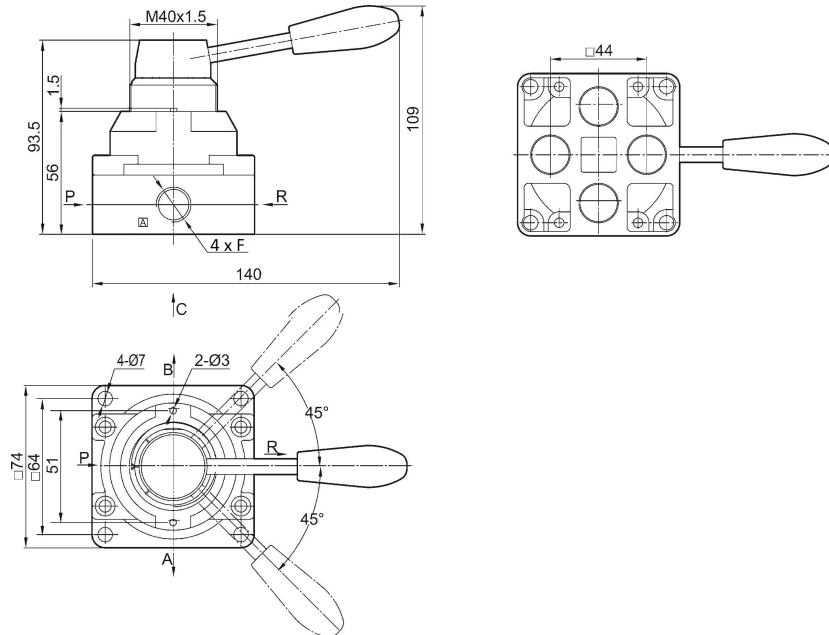

F

G 3/8"